



***Safety Together!***



# AeroSPI 2018 – Helicopter Rescue Hoist Thematic Design & Regulations

Lionel Tauszig, EASA

Senior Project Certification Manager  
for Continuing Airworthiness, Rotorcraft

**Your safety is our mission.**

An agency of the European Union 



# Hierarchy of hazard controls

most  
effective

eliminate

substitute

design

instructions/  
SOP/  
training

PPE

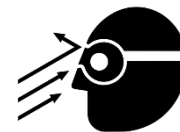
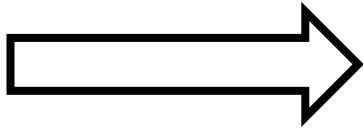

least effective



# Service history

- database of occurrences related to hoist design **ONLY**
- 300+ events dating back to
  - 22 Feb. 1955, in Maitland, New South Wales, Australia, a Royal Australian Navy Sycamore crashed following a cable rebound, **2 fatalities**



Royal Australian Navy



# Service history

## Fatalities and serious injuries potentially related to hoist design

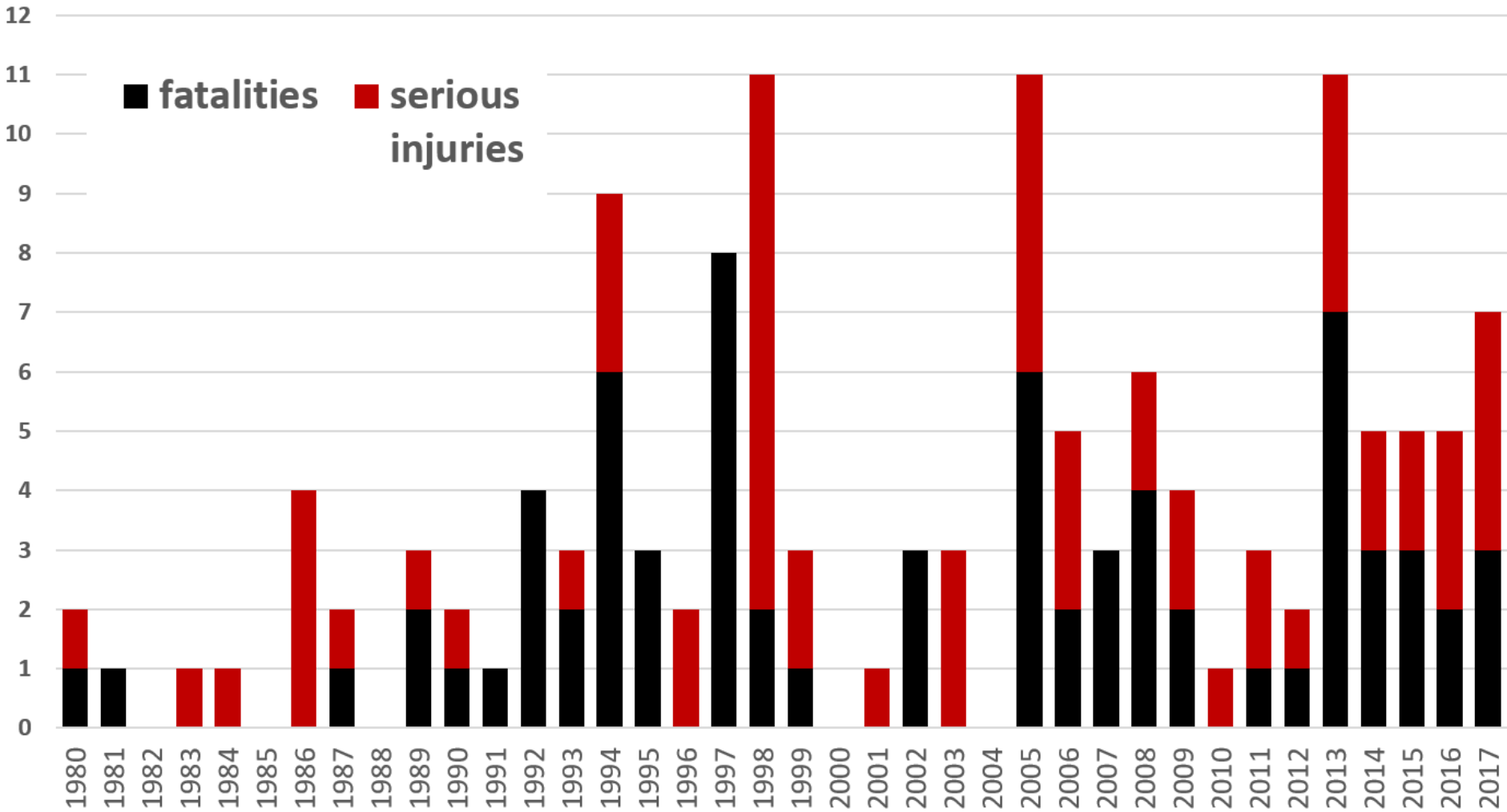



# Service history

Occurrence Categories

0 10 20 30 40 50 60 70 80

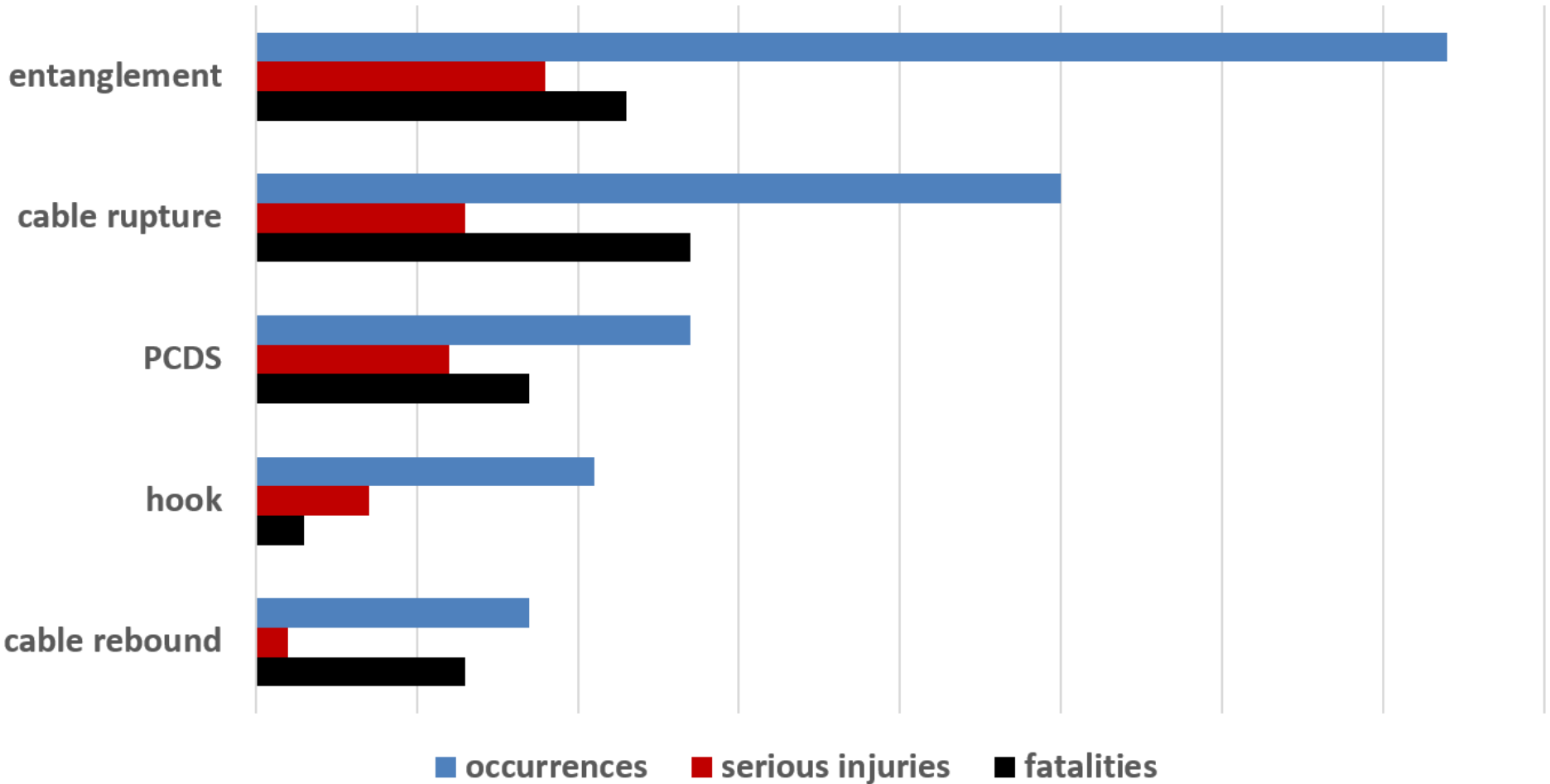



## Entanglements

resulting in  
cable rupture

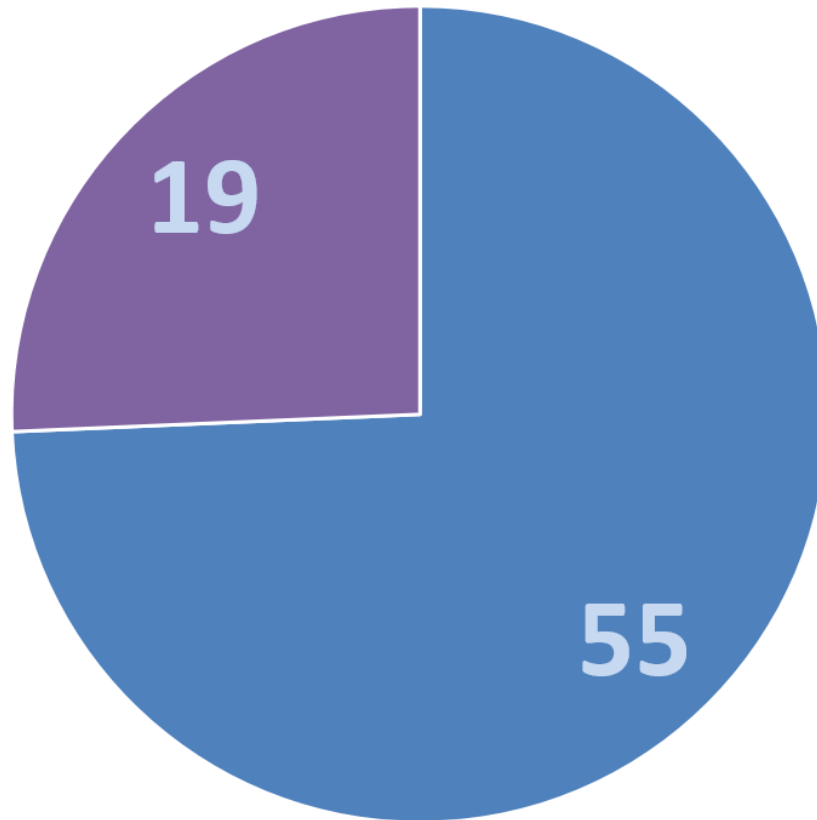



# Current regulation

all potential failure mode of the hoist or rescue hook system which may result in catastrophic failures, serious injuries, or fatalities are extremely improbable and any less significant failures are improbable.

  $<10^{-9}$  /flight

➤ **overload**

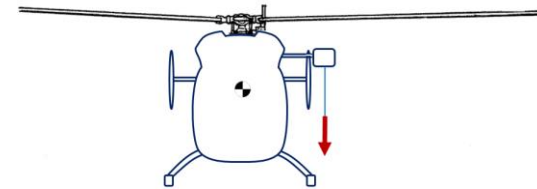

➤ **cable/structure rupture**

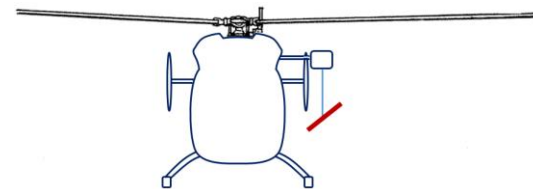

➤ **cable rebound**

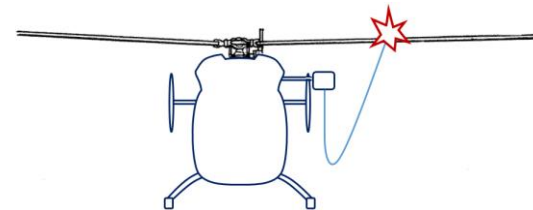



# Overload

- ▶ 24.12.2011 Wollongong, Australia  
NSW Ambulance, AW139  
ATSB AO-2013-136

Pulled from cliff with slack on the cable, hit the ground,  
**1 fatality, 1 serious injury.**

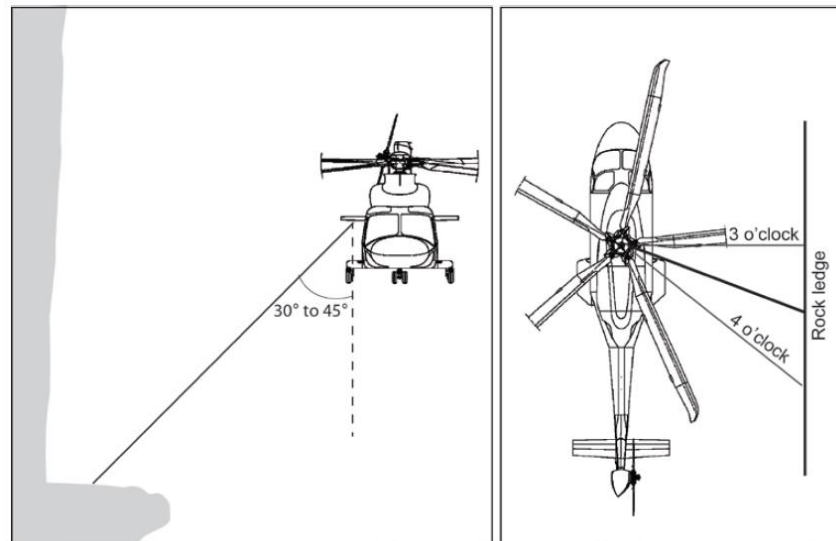

Source: ATSB





# Cable/structure rupture

- ▶ 04.09.2008 Oahu, HI, USA  
US Coast Guards, HH-65C  
USCG CG6505

Blade slap on hoist and damage to elastomeric transmission mounts, **4 fatalities.**

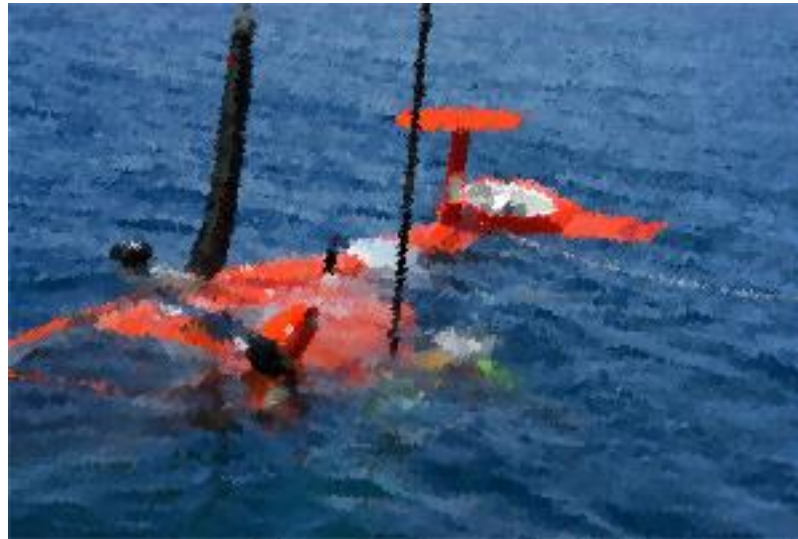



# Cable rebound

- 9.11.2009 Horn Island, Australia  
Queensland Health Rescue, Bell 412  
ATSB AO-2009-068

Entanglement on ship, rebound in main and tail rotor,  
**2 serious injuries.**



ATSB

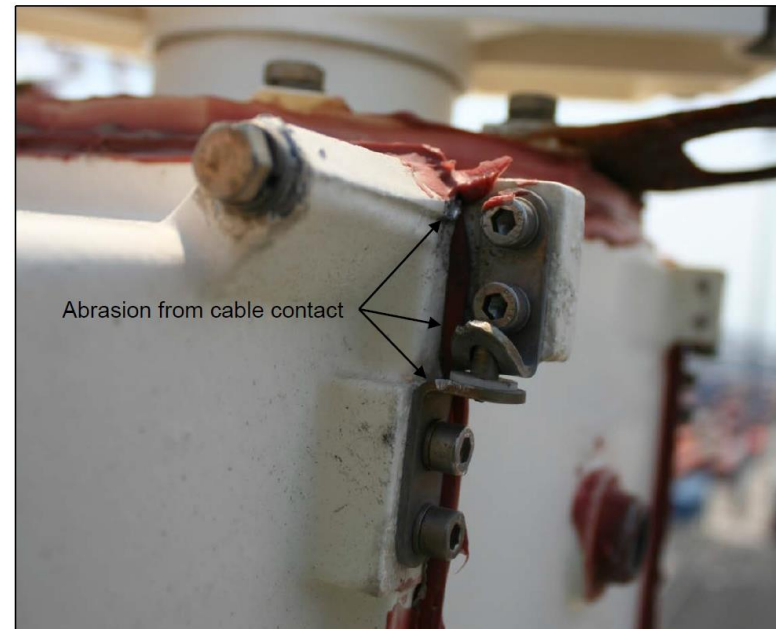

ATSB



# Cable rebound





# Design mitigation

➤ overload / rupture / rebound mitigation example:

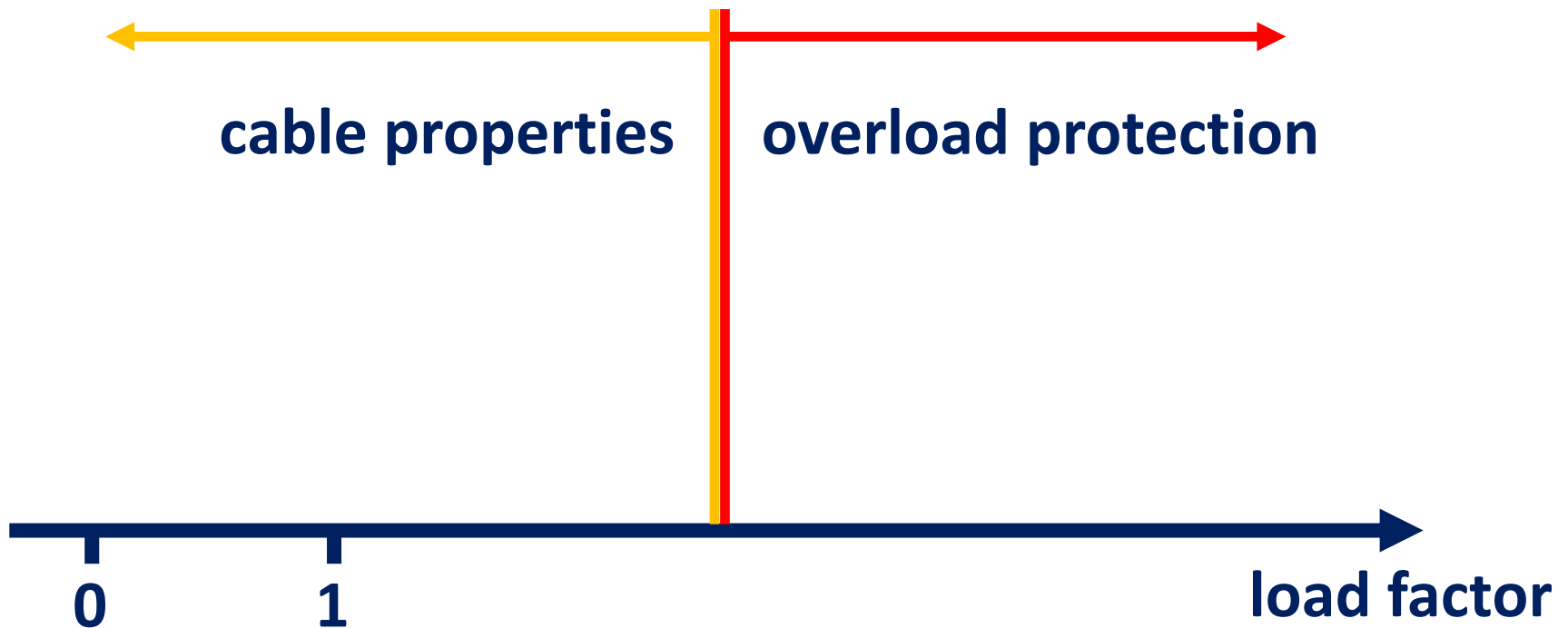



# Overload protection test

## ► Existing standards

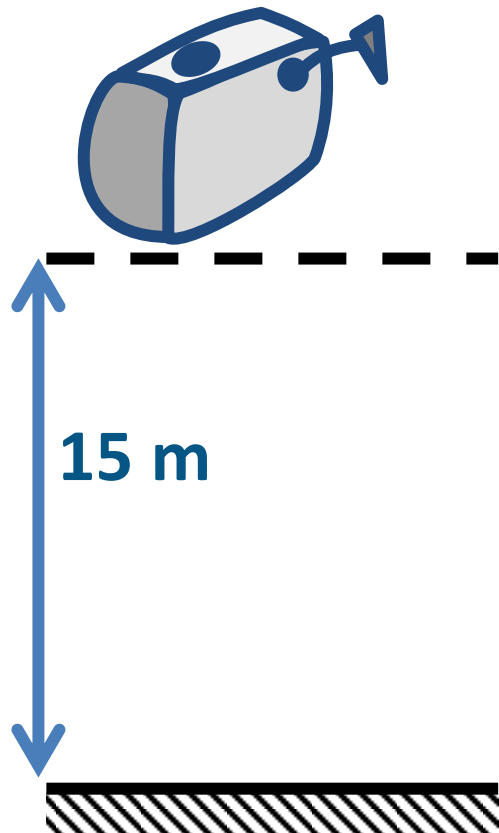

HeliOffshore



# Overload protection test

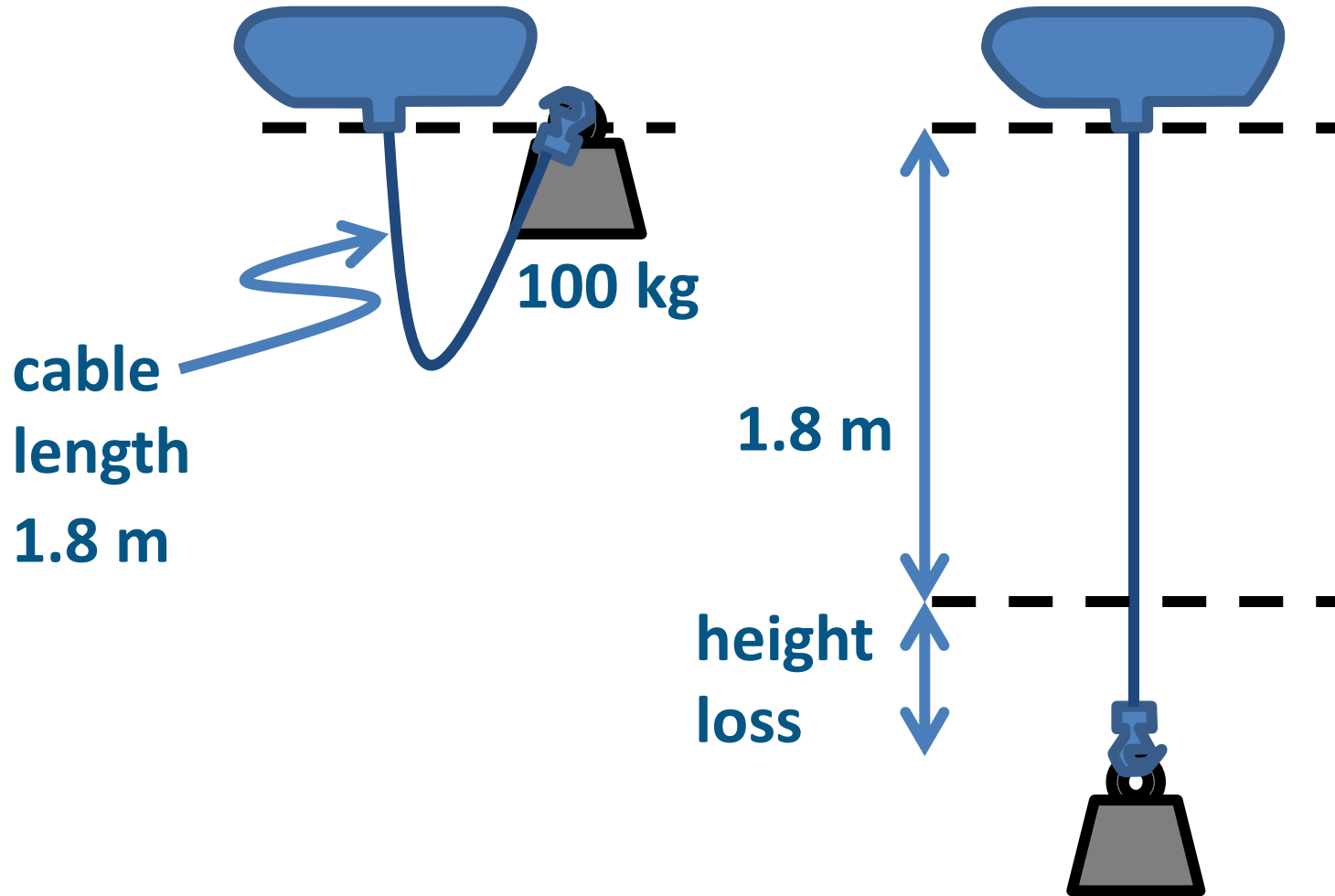



# Cable rebound test

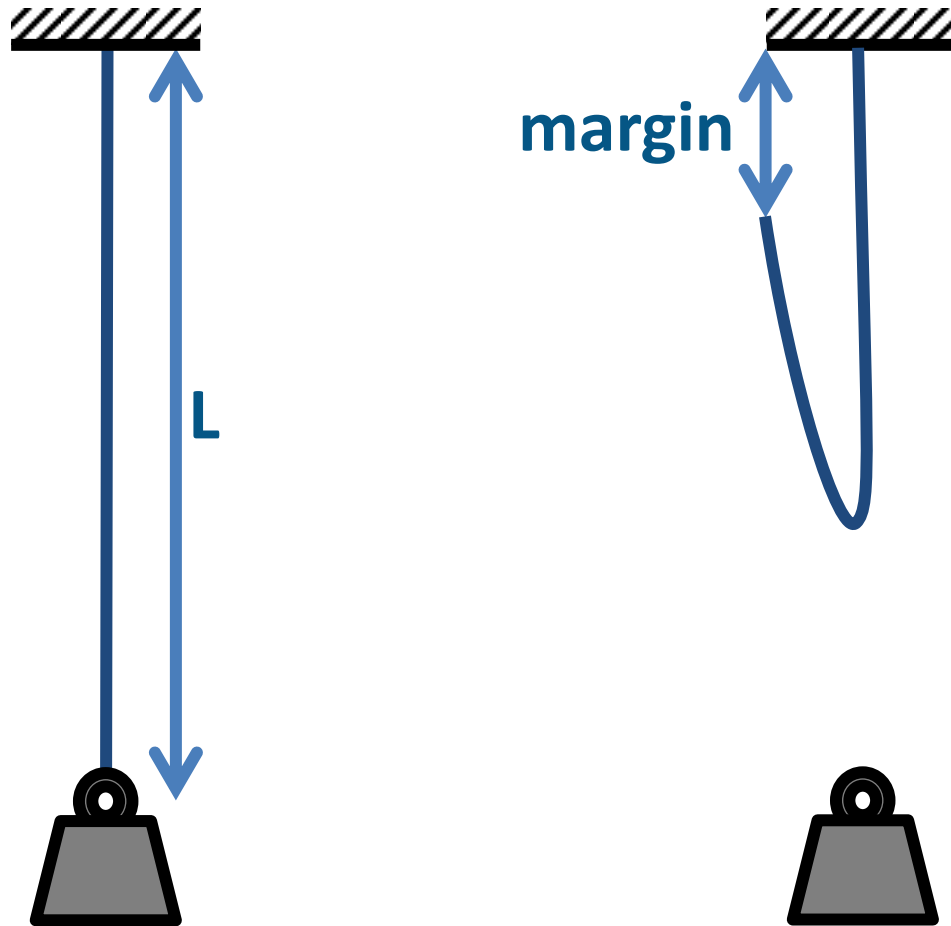



- **Drive and perform Safety Promotion with all actors involved**
- **Propose standards and tests within an industry group (SAE G-26) for possible incorporation in a TSO/ETSO**





## ➤ Publish Safety Information Bulletins

- e.g. “Dynamic Rollout during Hoisting and/or External Sling Load Operations”

<https://ad.easa.europa.eu/ad/2016-18R1>

## ➤ Issue Certification Memoranda

- “Safety considerations covering External Loads”
- “Helicopter External Loads Personnel Carrying Device System”

<https://www.easa.europa.eu/document-library/public-consultations/certification-memoranda>



## ➤ Propose Acceptable Means of Compliance

- Certification Specifications 27 and 29 Amdt 5

<https://www.easa.europa.eu/regulations#regulations-initial-airworthiness>

## ➤ Lead and perform Rule Making Tasks (RMTs) within the European Plan for Aviation Safety (EPAS)

- e.g. RMT.0709 – “Prevention of catastrophic accidents due to rotorcraft hoist issues – Improvement of CS and Standards”



**EASA**  
European Aviation Safety Agency

**Questions?**

**Your safety is our mission.**

An agency of the European Union 